

Article number: 01010221
 Description: Retaining ring A 9 DIN 471
 Stainless 411
 Note: Fitted with ZGA pilers

Measures

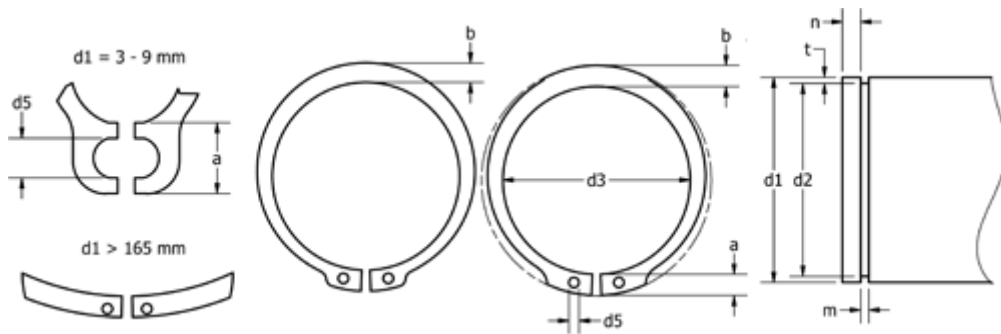

a max	= 3.3	FN kN	= 0.9	s	= 1.00
AN mm ²	= 5.5	FRg kN	= 2.40	t	= 0.20
b	= 1.7	FR kN	= 3.50	tol	= -0.06
d1	= 9	g	= 0.5	tol	= -0.06
d2	= 8.6	K kN-mm	= 30.00	tol	= +0,06-0,18
d3	= 8.4	m min	= 1.10	Tong	= ZGA-0
d5 min	= 1.2	n abl x 1000	= 85.0	Weight kg/1000	= 0.300
Description	= A9	Nominal drive	= 0.6		